

100 2721 exp
 STEINBERG

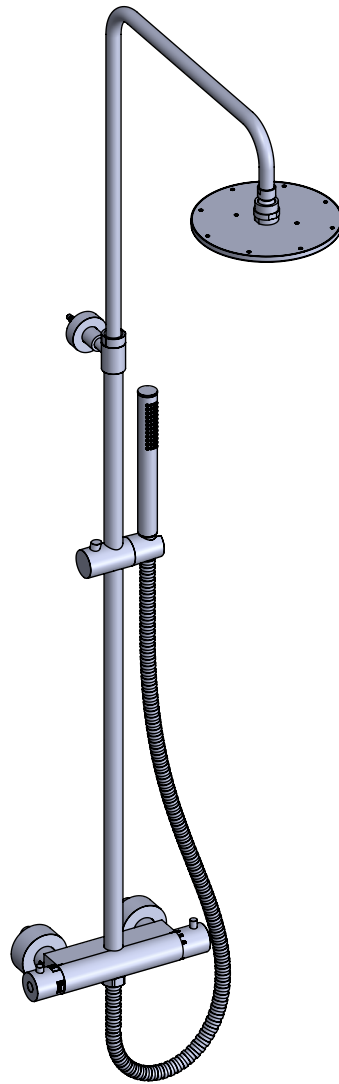

PartNo	DE	EN	
1	099 9821	Kugegelenk zur Regenbrause, Chrom	ball joint of rain shower, chrome
2	100 1687	Regenbrause mit Easy Clean Ø200mm x 8mm, Chrom	rain shower with Easy Clean Ø200mm x 8mm, chrome
3	099 2730	Obere Brausestange mit Wandhalterung, Chrome	upper shower rail, with wall bracket, chrome
4	099 2732	Wandhalterung komplett, Chrom	wall fixing set complete, chrom
5	099 2731	unterer Brausestange mit Gleiter, Chrom	lower shower rail with slider, chrome
6	099 9890	S-Anschlüsse ½" (Paar)	s-connections ½" (pair)
7	099 9877	Rosette Ø68mm mit O-Ring (Paar), Chrom	rosette Ø68mm with o-ring (pair), chrome
8	099 3231	Überwurfmutterkomponenten (Set), Chrom	hexagonnut components (set), chrome
9	099 9160	Rückflussverhinderer Ø14 mm	back flow preventer Ø 14 mm
10	100 9934	Umstell Griff komplett, Chrom	diverter handle complete, chrome
11	099 2716	Überwurfmutter zu Umstellkartusche	hexagonnut for diverter cartridge
12	099 9070	Umstell Kartusche "Flühs"	diverter cartridge "Flühs"
13	099 9063	Thermostat Kartusche "Vernet"	thermostatic cartridge "Vernet"
14	099 2715	Überwurfmutter zu THM Kartusche	hexagon nut of thermostatic cartridge
15	099 2744	Anschlagring 38° zur THM Kartusche	plastic ring to govern for thermostatic cartridge
16	100 9933	Thermostat Griff komplett, Chrom	thermostatic handle complete, chrome
17	099 4101	Abdeckkappe groß, Chrom	cover cap, chrome
18	099 9412	Metall-Brauseschlauch, Ü ½" mit Konus ½", Chrom	metal shower hose, Ü ½" with cone seat ½", chrome
19	099 9511	Kunststoff Stabhandbrause mit Easy Clean, Chrom	hand shower with Easy Clean, pvc, chrome
20	099 9510	Kunststoff Gleiter mit Halter komplett, Chrom	pvc rail slider with holder complete, chrome
21	100 3231	Ersatz-Thermostatarmatur komplett einzeln, Chrom	thermostatic mixer complete separately, chrome
			100 2721
			12.02.2021
			STEINBERG