

STEINBERG



# Waschtisch-Einhebelmischbatterie

Art.Nr.160 1511

## Installation

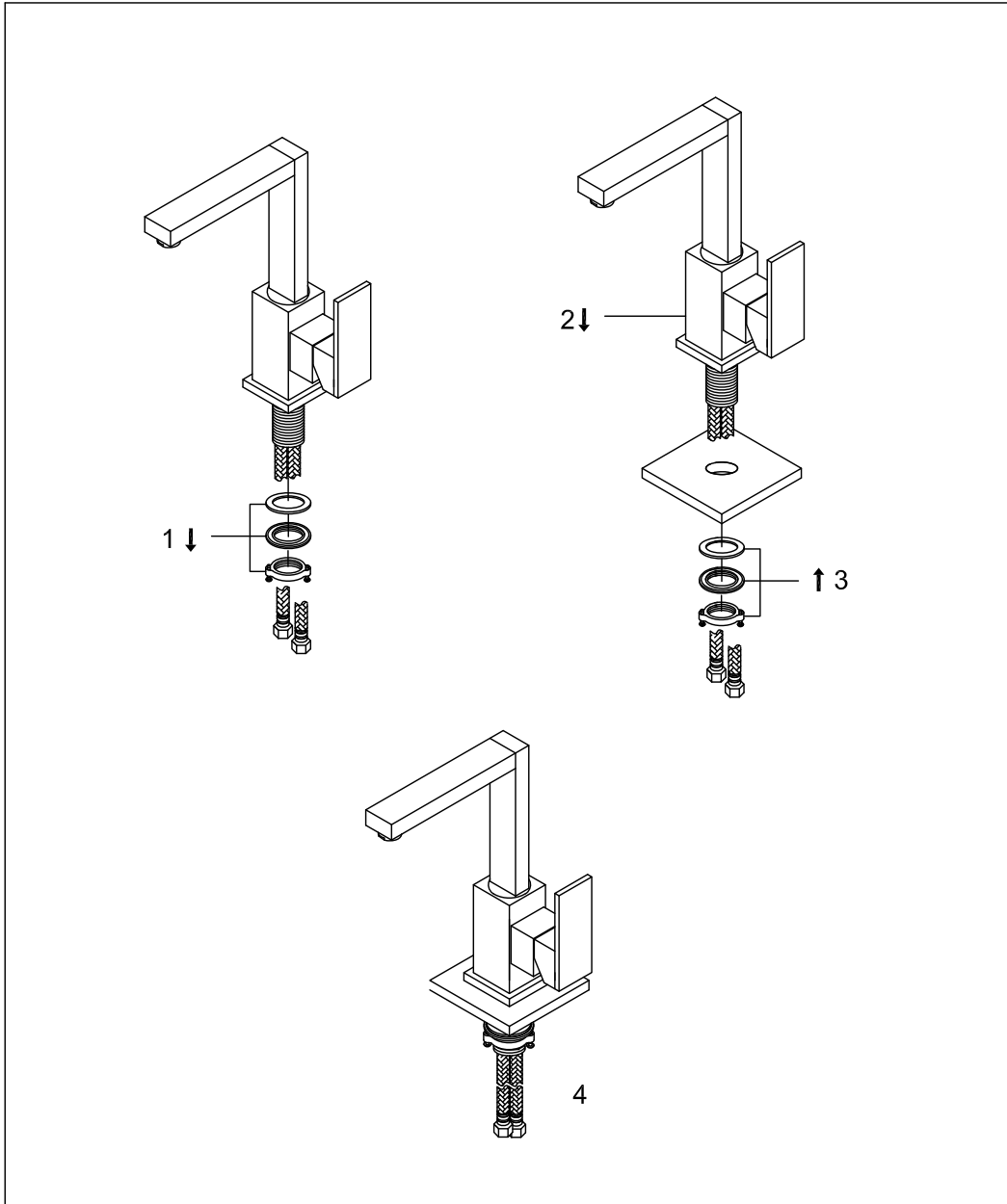

## Technische Zeichnung

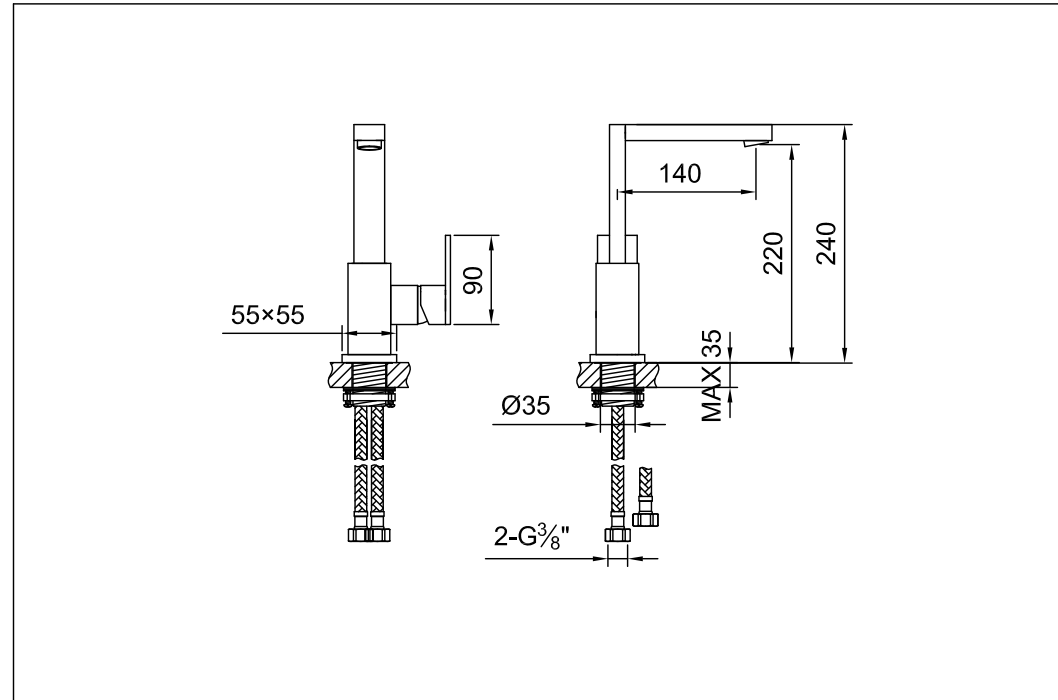

## Explosionszeichnung

