

STEINBERG



Waschtisch-Einhebelmischbatterie

Art.Nr.160 1710

Installation

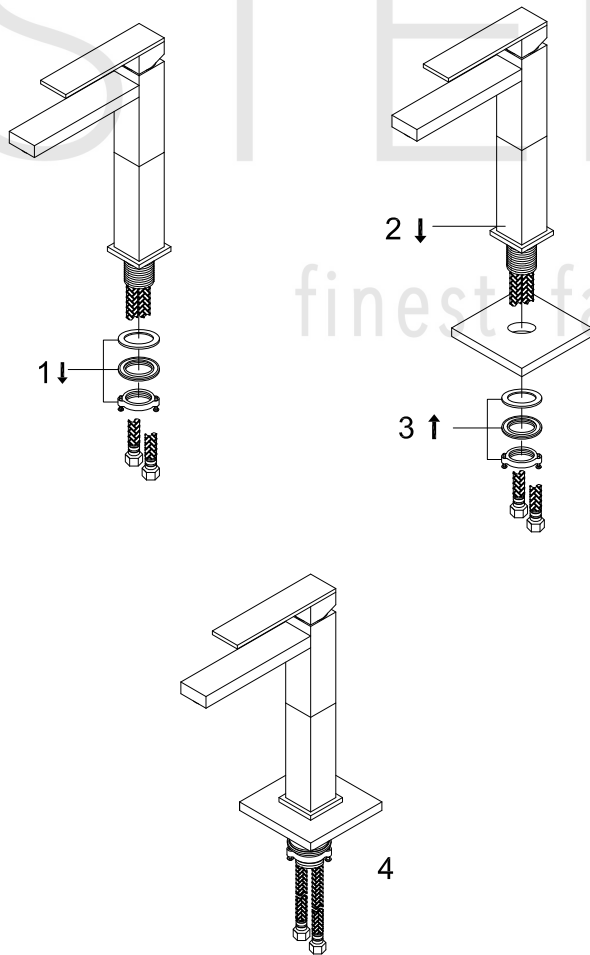

Technische Zeichnung

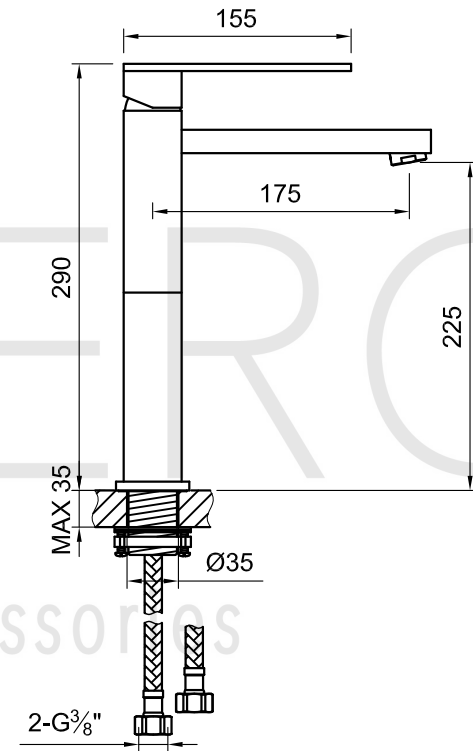

Explosionszeichnung

