

STEINBERG



Brause-Aufputzthermostat 1/2"

Art.Nr.340 3200

Installation

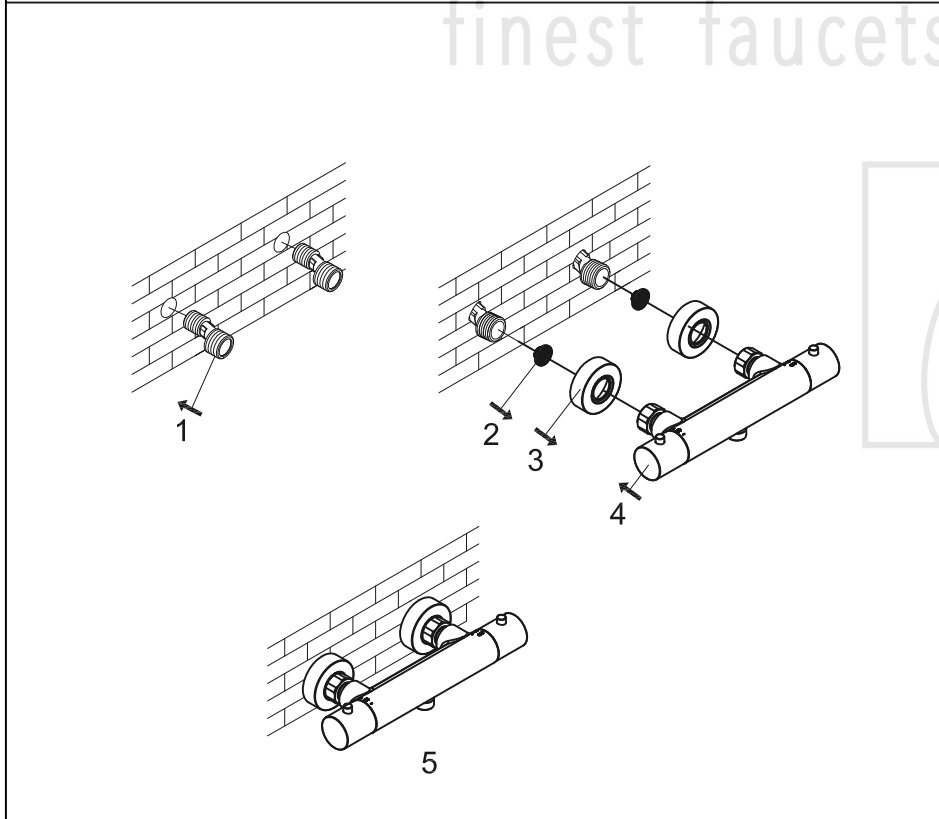
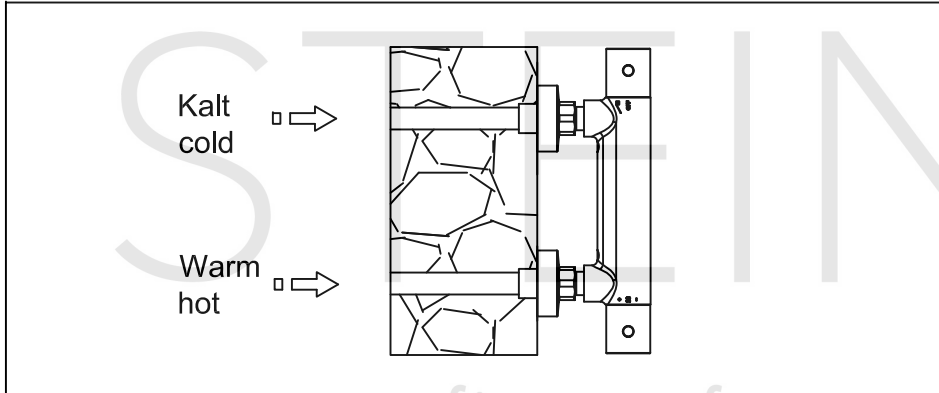

Technische Zeichnung

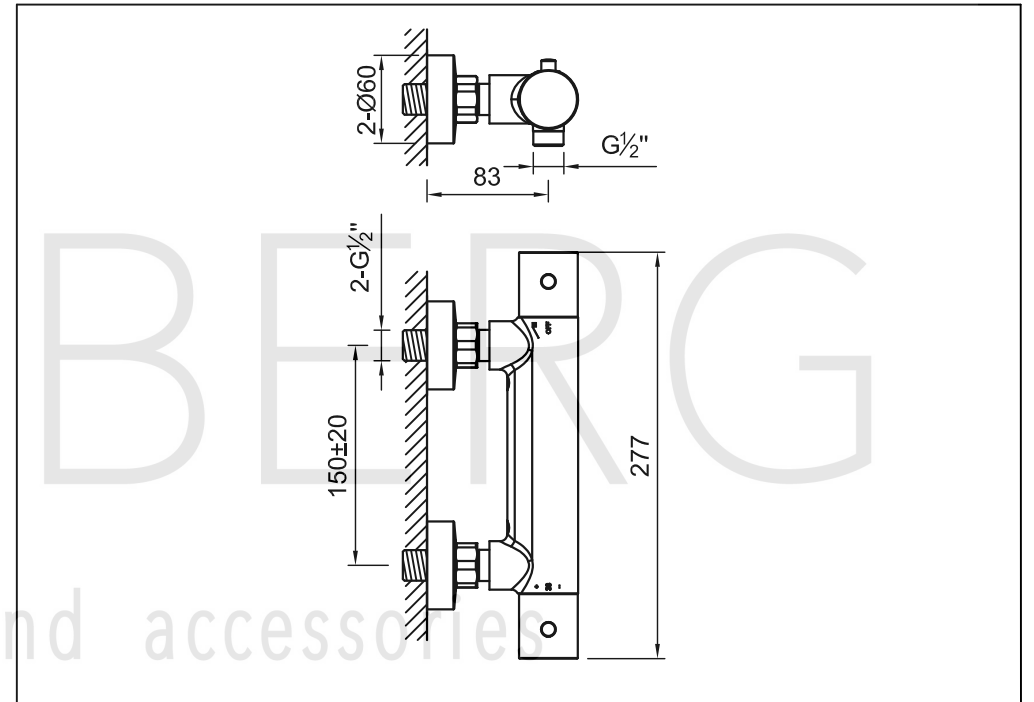

Explosionszeichnung

